

Instructions for Use



CE

assistina^{ONE}

MB-301

Contents

Symbols	4
1. Introduction	7
2. Unpacking	9
3. Scope of delivery	10
4. Safety notes	11
5. Description	12
Front panel	12
Quick ISO/Quick RM adaptor	13
Rear panel/underside	14
6. Start-up	15
Inserting the swivel window.....	15
Inserting/removing a filter	16
Inserting/removing a cartridge.....	17
Connecting/disconnecting the air connection hose	18
Initial filling	19
Test run.....	21
7. Operation	22
General	22
Loading/removing with Quick ISO adaptor	23
Loading/removing with Quick RM adaptor.....	25
Maintenance process	26
Lubrication of the chucking system	27

Contents

8. Cleaning	29
Preparation.....	30
Swivel window.....	31
Start-up after cleaning.....	32
9. Maintenance	33
Replacing O-rings.....	33
Replacing the air filter	34
10. W&H Accessories and spare parts	35
11. Servicing	37
12. Technical data	38
13. Disposal	39
Explanation of warranty terms	40
Authorized W&H service partners	41

Symbols

in the Instructions for Use



WARNING!
(risk of injury)



ATTENTION!
(to prevent damage occurring)



General explanations,
without risk to
persons or property



CE mark



Do not dispose of with
domestic waste

Symbols

on the medical device



Consult Instructions
for Use



Do not dispose of with
domestic waste

REF

Catalogue number



Date of manufacture



Data Matrix code
for product information
including UDI (Unique
Device Identification)

SN

Serial number



CE mark



Manufacturer



Medical Device

Symbols

on the packaging/cartridge



This way up



CE mark



Consult Instructions for Use



Fragile, handle with care



Keep away from heat



Trademark of RESY OfW GmbH for identification of recyclable transport and outer packaging of paper and cardboard



Keep dry



Use by



“Der Grüne Punkt” (The Green Dot) trademark of Duales System Deutschland GmbH

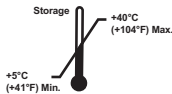

Permitted temperature range for storage



Caution! Federal law restricts this device to sale by or on the order of a physician, dentist, veterinarian or with the descriptive designation of any other practitioner licensed by the law of the State in which the practitioner practices to use or order the use of the device.



Manufacturer

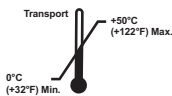

Permitted temperature range for transport



Medical Device

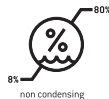

Humidity, limitation

1. Introduction

For your safety and the safety of your patients

Prior to initial use please read the Instructions for Use. These explain how to use your medical device and guarantee a smooth and efficient operation.



Observe the safety notes.

Intended use

Unit for cleaning the spray channels and lubricating the moving parts of dental transmission instruments, turbines, air motors and air-driven dental scalars.



Misuse may damage the medical device and hence cause risks and hazards for user and third parties.

When transmission instruments are prepared with the medical device, they are neither disinfected nor sterilized. After cleaning of the spray channels and lubrication of the transmission instruments with the medical device, they subsequently need to be disinfected and sterilized.

Qualifications of the user

We have based the development and design of the medical device on the target group of dentists, dental hygienists and dental assistants.

Introduction

Responsibility of the manufacturer

The manufacturer can only accept responsibility for the safety, reliability and performance of the medical device when it is used in compliance with the following directions:

- > The medical device must be used in accordance with these Instructions for Use.
- > The medical device has no components that can be repaired by the user (with the exception of replacing the O-rings, cartridges, filter and air filter). Assembly, modifications or repairs must only be undertaken by an authorized W&H service partner (see page 41).
- > Unauthorized opening of the equipment invalidates all claims made under warranty and any other claims.

Improper use

Improper use and unauthorized assembly, installation and modification of or repairs to the medical device or failure to comply with our instructions invalidates all claims under warranty and releases us from all other claims!



Any serious incident that has occurred in relation to the medical device should be reported to the manufacturer and the competent authority!

2. Unpacking

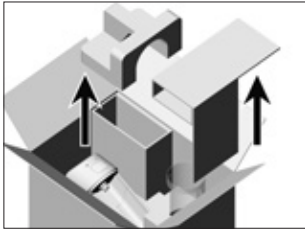

- 1 Remove the inserts.

W&H packaging is environmentally friendly and can be disposed of by industrial recycling companies.

However, we recommend that you keep the original packaging.

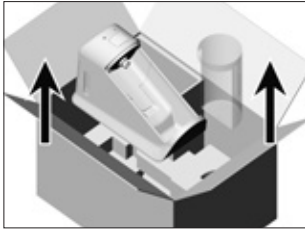

- 2 Lift out the medical device and swivel window.

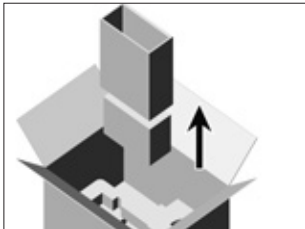

- 3 Remove the cardboard box with the:
 - > air connection hose
 - > adaptor
 - > One Care SET.

3. Scope of delivery

		W&H Assistina One (MB-301)		
		REF 30398001	REF 30398002	REF 30398003
REF 02697000	Air connection hose	X	X	X
REF 08064970	One Care SET MB-301: <ul style="list-style-type: none"> > W&H Activefluid cartridge, MC-302, 200 ml > W&H Service Oil F1 cartridge, MD-302, 200 ml > filter 	X	X	X
REF 06422600	Quick ISO adaptor	X		X
REF 06395100	Quick RM adaptor		X	X

4. Safety notes



Please observe the following instructions under all circumstances

- > Only set up the product in sufficiently well ventilated rooms!
- > Always close the sliding window before you use the medical device!



Place the medical device on a flat, level surface.

Process fluids



- > If inhaled: Supply fresh air; consult doctor in case of complaints.
- > Following contact with skin: Wash off with soap and plenty of water.
- > Following contact with eyes: Rinse opened eye for several minutes under running water. If symptoms persist, consult a doctor.
- > If swallowed: If symptoms persist, consult a doctor.
- > Only use process fluids which have been approved by the manufacturer.

Approved process fluids

- > W&H Activefluid, MC-302
- > W&H Service Oil F1, MD-302

Cartridges



- > Replace cartridges immediately if they display faults or leak!
- > Do not expose the cartridges to direct sunlight!



The cartridge spike in the medical device is sharp.
Be careful not to injure yourself on the projecting spike.

5. Description

Front panel

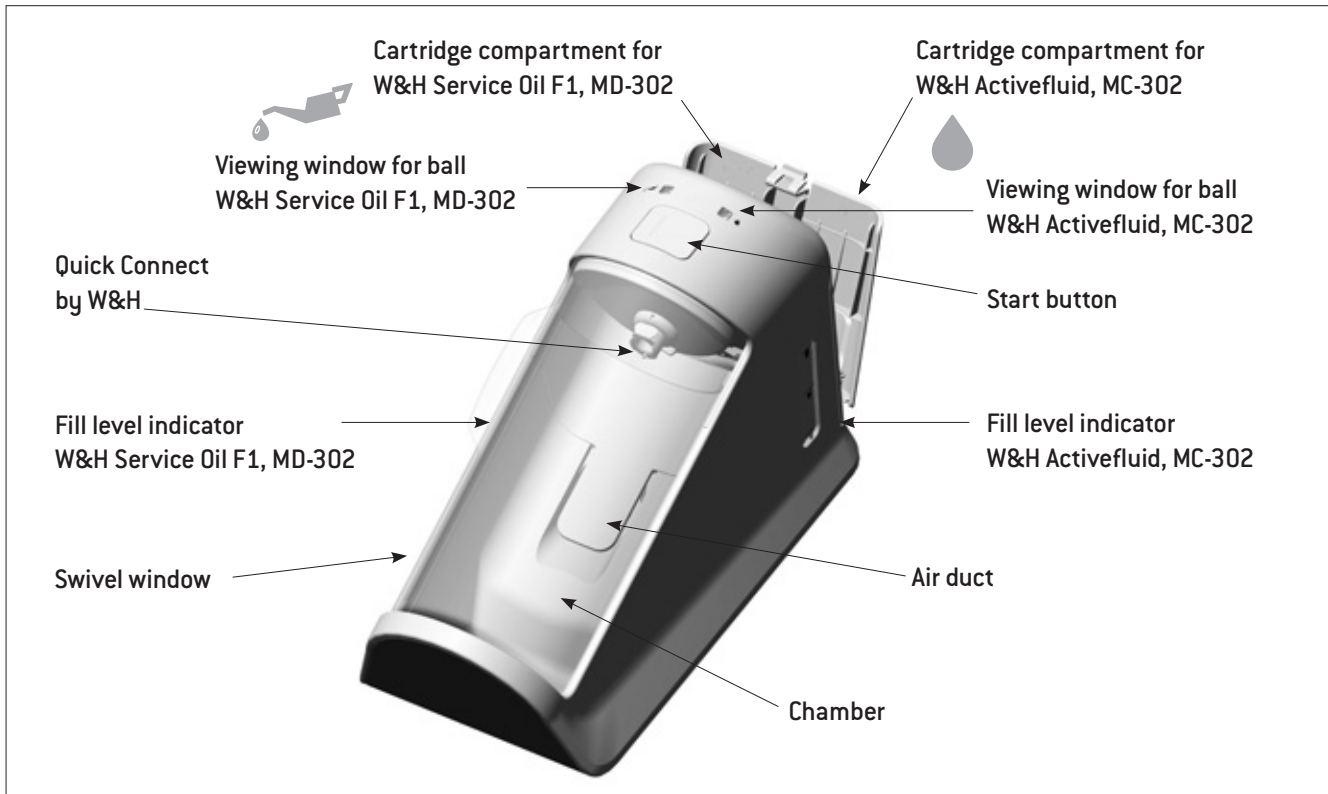

Description

Quick ISO/Quick RM adaptor

Quick ISO adaptor

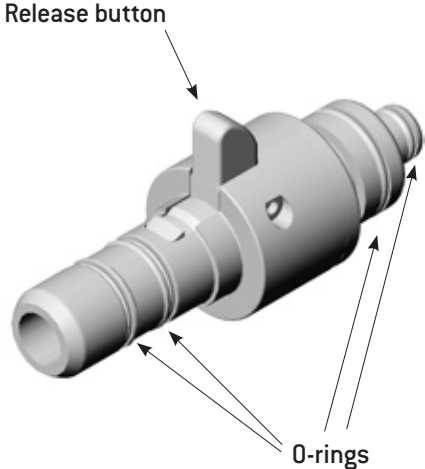

Quick RM adaptor

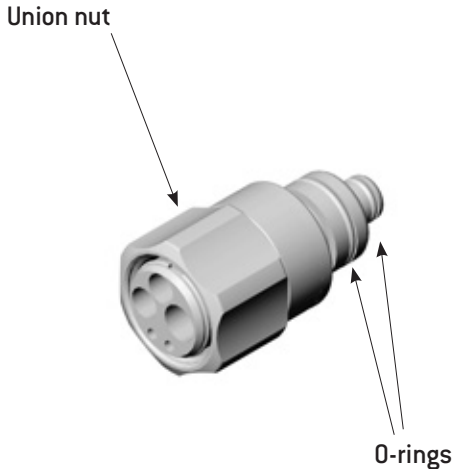

Description

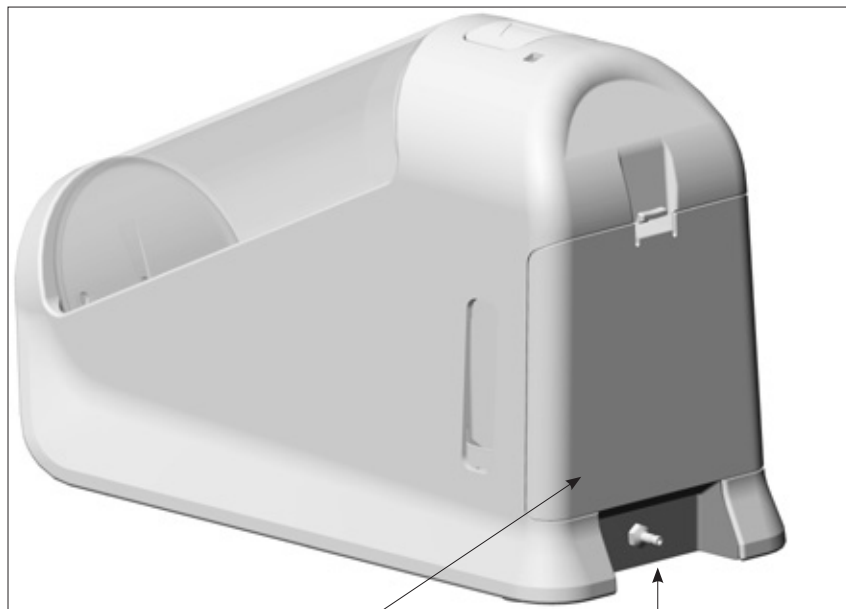

Cartridge
compartment cover

Connecting socket for
air connection hose

Rear panel/underside



Filter
compartment cover

6. Start-up

Inserting the swivel window



- 1 Insert the swivel window.

Start-up

Inserting/removing a filter



- > Check the filter for damage, e.g. vents, seal.
- > Only perform the maintenance process with a functional filter.



- ❶ Turn the medical device over.

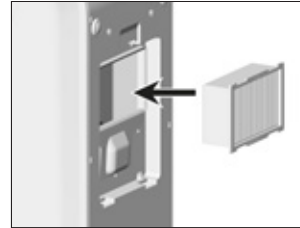

- ❸ Push the filter in until the limit stop is reached.

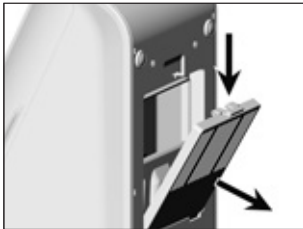

- ❷ Remove the filter compartment cover.



- ❹ Close the filter compartment cover.



Whenever you replace a filter

- > disconnect the air connection hose
 - > clean the cartridge compartment
- Observe the manufacturer's instructions on the use of disinfectant.

Start-up

Inserting/removing a cartridge



The cartridges must be at room temperature when they are inserted.



The cartridge spike in the medical device is sharp.
Be careful not to injure yourself on the projecting spike.

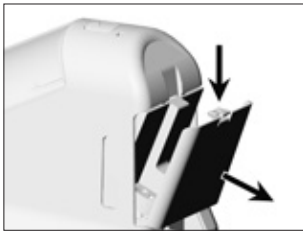

- 1** Open the cartridge compartment cover

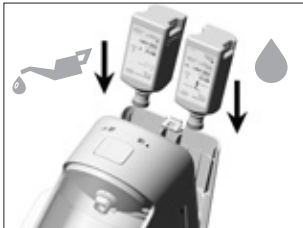

- 2** Inserting a cartridge
Push the cartridge in until the limit stop is reached.



- 3** Removing a cartridge
Pull out the cartridge.



- 4** Close the cartridge compartment cover.



Whenever you replace a cartridge:

- > always clean the cartridge compartment,
- > perform the initial filling.

Observe the manufacturer's instructions on the use of disinfectant.



Use only non-contaminated, oil-free, dry and filtered compressed air according to ISO 7494-2.
Replace the filter if contaminated.

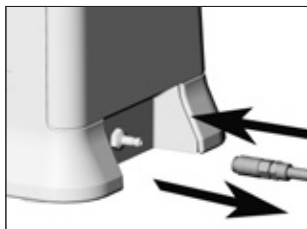

- 1 Connect the air connection hose.
- 2 Disconnect the air connection hose.

 Carry out the initial filling without a Quick ISO/Quick RM adaptor and transmission instrument.



❶ Close swivel window.



❷ Press the Start button.



- > The start button returns to its initial position with an audible click.
- > Press the start button again after this.

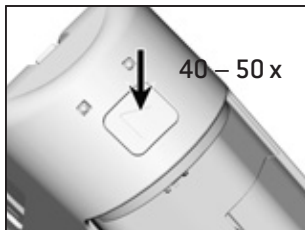

③ Repeat the initial filling 40 – 50 times.



- > Take note of the position of the start button.
- > A green ball appears in each of the two viewing windows.



- > After a few seconds, both balls will sink again.
- > The initial filling has completed successfully.

If both balls are not visible or do not sink again during the initial filling

- > Repeat the initial filling.

- > Place a disinfected transmission instrument onto the Quick Connect.
- > Start the Assistina One.



The transmission instrument will be slightly moist when you take it out. It then needs to be manually disinfected and sterilized.



In the event of operating malfunctions (e.g., vibrations, unusual noise, overheating, failure or leakage) **stop the medical device immediately** and contact an authorized W&H service partner.



Wear protective clothing, safety glasses, face mask and gloves.





Refer to the »hygiene and maintenance« instructions in the instructions for use of the transmission instruments.

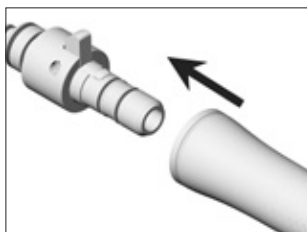

Replace damaged or leaking O-rings immediately.

Loading the transmission instruments with ISO connection



- 1 Push the transmission instrument onto the adaptor, with the coolant outlet facing downwards.
 For air motors, set the direction of rotation via the switching ring to clockwise or anti-clockwise. No maintenance is carried out in the »0« position.



- 2 Push on the transmission instrument with adaptor.

Removing the transmission instruments with ISO connection

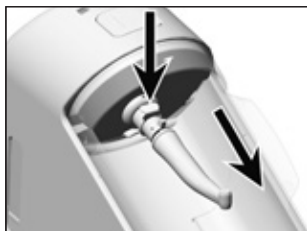

❶ Press the release button and pull off the transmission instrument with adaptor.

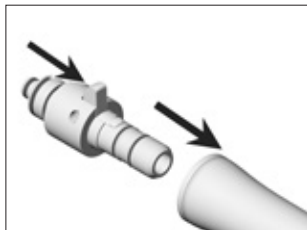

❷ Tip the release button on the adaptor forwards and remove the transmission instrument.

Loading of the transmission instruments and/or adaptors with fixed RM connection

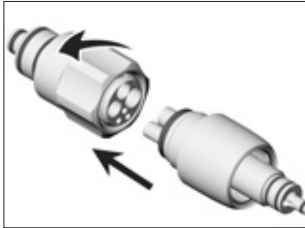

- 1 Push on the transmission instrument and/or adaptor on the Quick RM adaptor and tighten the union nut anti-clockwise by hand.



- 2 Push on the Quick RM adaptor with transmission instrument or, if applicable, the adaptor with transmission instrument.

Removing of the transmission instruments and/or adaptors with fixed RM connection



- 1 Press the release button and pull off the Quick RM adaptor, transmission instrument or, if applicable, adaptor with transmission instrument.

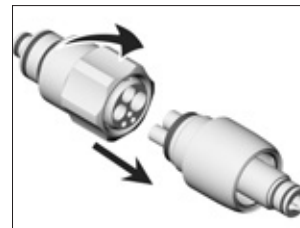

- 2 Unscrew the union nut by hand in a clockwise direction and remove the transmission instrument/adaptor.

 The amount of W&H Activefluid, MC-302 and W&H Service Oil F1, MD-302 used in the maintenance process is carefully metered.



❶ Close swivel window.



❷ Press the Start button.

-  > The maintenance process runs automatically and takes approx. 20 seconds.
> A green ball appears in each of the two viewing windows.

-  > The balls sink again.
> The maintenance process has completed successfully.

If both balls are not visible or do not sink again during the maintenance process

- > Check cartridges and replace if necessary.
- > Repeat the maintenance process.

- > Remove the rotary instrument.
- > Use the Quick ISO adaptors REF 06422600 and REF 02693000.



- 1 Insert the adaptor with the maintenance attachment facing downwards.



- 2 Align the instrument with the outlet.



3 Press the Start button.



- > The lubrication runs automatically and takes approx. 20 seconds.
- > A green ball appears in each of the two viewing windows.



- > The balls sink again.
- > The lubrication has completed successfully.



4 Remove the adaptor.



Wear protective clothing, safety glasses, face mask and gloves.
Aerosol mist escapes.

8. Cleaning

the Assistina One



- > Follow your local and national laws, directives, standards and guidelines for cleaning and disinfection.
- > W&H recommends cleaning the medical device at least once daily or as required.



Wear protective clothing, safety glasses, face mask and gloves.



Cleaning agents

Use only detergents which are intended for cleaning medical devices made of metal and plastic.

Preparation



- 1 Disconnect the air connection hose.

Remove swivel window.



- 1 Close swivel window.



- 3 Remove swivel window.



- 2 Push swivel window upwards.

Manual cleaning of the interior and exterior



Clean the chamber with a dry cloth.

Wipe down the exterior and the chamber with disinfectant.

Swivel window

Manual cleaning of the interior and exterior

Rinse the sliding window off with running tap water (<35°C / 95°F) and wipe down with disinfectant.

Start-up after cleaning



❶ Position the swivel window.



❷ Insert the swivel window.

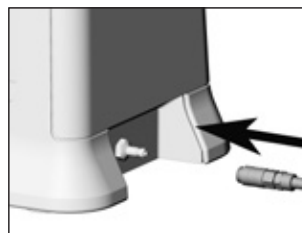

❸ Connect the air connection hose.

9. Maintenance

Replacing O-rings



Replace damaged or leaking O-rings immediately.
Do not use sharp tools!

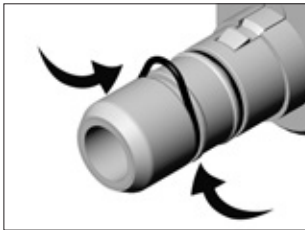

❶ Firmly squeeze the O-ring between your thumb and index finger so that it forms a loop.



❷ Pull off the O-ring.



❸ Slide on a new O-ring.

Maintenance

Replacing the air filter



Switch off the central air supply before replacing the air filter.



- > Replace the air filter whenever it is dirty or at least once per year.
- > Only use clean, filtered compressed air.



- ❶ Remove the air connection hose.

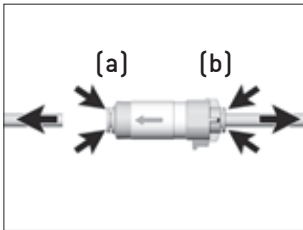

- ❷ Push the ring [a, b] towards the air filter and detach the air hose.

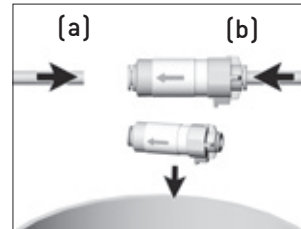

- ❸ Replace the air filter and reconnect the air hose [a, b].

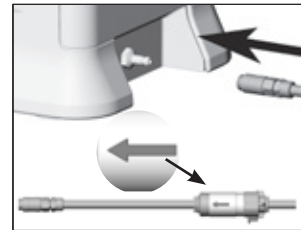

- ❹ Connect the air hose.
Pay attention to the flow direction of the air filter.

10. W&H Accessories and spare parts



Use only original W&H accessories and spare parts or accessories approved by W&H!



06395100
Quick RM adaptor

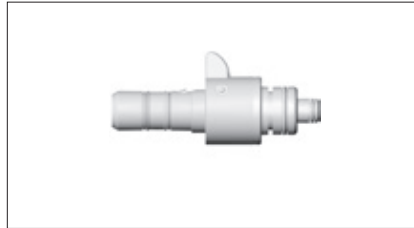

06422600
Quick ISO adaptor



02693000
Adaptor for lubricating the
chucking system

For other adapters and a full system overview, scan the QR code



W&H Accessories and spare parts



02697000

Air connection hose 2 m



08064970

One Care SET
MB-301

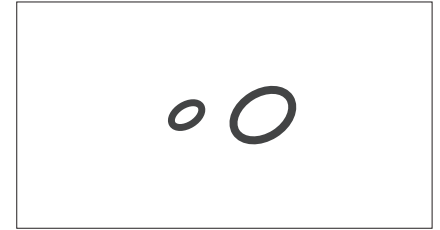

02060100

O-Ring, Roto Quick adaptor, large

02060200

O-Ring, Roto Quick adaptor, small

03006100

O-Ring, Quick RM and
Quick ISO adaptor, large

01208300

O-Ring, Quick RM and
Quick ISO adaptor, small

02695700

O-ring, Quick ISO adaptor



02675200

Air filter

11. Servicing

Repairs and returns

In the event of operating malfunctions immediately contact an authorized W&H service partner.
Repairs and maintenance work must only be undertaken by an authorized W&H service partner.



Always return equipment in the original packaging!

12. Technical data

Assistina One	MB-301
Air consumption:	approx. 50 NI/min.
Operating pressure:	5 – 10 bar (controlled via an integrated, automatic pressure controller)
Volume:	60 dB
Dimensions in mm (WxDxH):	166 x 383 x 243 mm
Weight:	2.2 kg
Capacity:	200 ml W&H Activefluid, MC-302 200 ml W&H Service Oil F1, MD-302
Ambient conditions	
Temperature during transport:	0 °C to +50 °C (+32 °F to +122 °F)
Temperature during storage:	+5°C to +40 °C (+41 °F to +104 °F)
Ambient temperature during operation:	+10 °C to +40 °C (+50 °F to +104 °F)

13. Disposal



Ensure that the parts are not contaminated on disposal.



Follow your local and national laws, directives, standards and guidelines for disposal.

> Medical device



> Packaging

Explanation of warranty terms

This medical device has been manufactured with great care by highly qualified specialists. A wide variety of tests and controls guarantee faultless operation. Please note that claims under warranty can only be validated when all the directions in the instructions for use have been followed.

As the manufacturer, W&H is liable for material or manufacturing defects within a warranty period of 12 months from the date of purchase.

We accept no responsibility for damage caused by incorrect handling or by repairs carried out by third parties not authorized to do so by W&H.

Claims under warranty – accompanied by proof of purchase – must be sent to the vendor or to an authorized W&H service partner. The provision of service under warranty extends neither the warranty period nor any other guarantee period.

12 months warranty

Authorized W&H service partners

Find your nearest W&H service partner at <http://wh.com>
Simply go to the menu option »Service« for full details.

Or simply scan the QR code.



Manufacturer

W&H Dentalwerk Bürmoos GmbH
Ignaz-Glaser-Straße 53, 5111 Bürmoos, Austria

t + 43 6274 6236-0, f + 43 6274 6236-55
office@wh.com wh.com

Form-Nr. 51046 AEN
Rev. 001 / 26.07.2022
Subject to alterations